

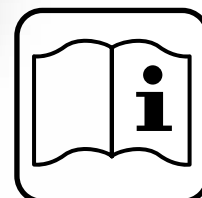

# STAYER

## MINI COM 12V

- ES** Manual de instrucciones
- IT** Istruzioni d'uso
- GB** Operating instructions
- FR** Instructions d'emploi
- P** Manual de instruções



Área Empresarial Andalucía - Sector 1  
C/ Sierra de Cazorra, 7  
28320 - Pinto (Madrid) SPAIN  
Email: sales@grupostayer.com  
Email: info@grupostayer.com

[www.grupostayer.com](http://www.grupostayer.com)





**FIG. 1**

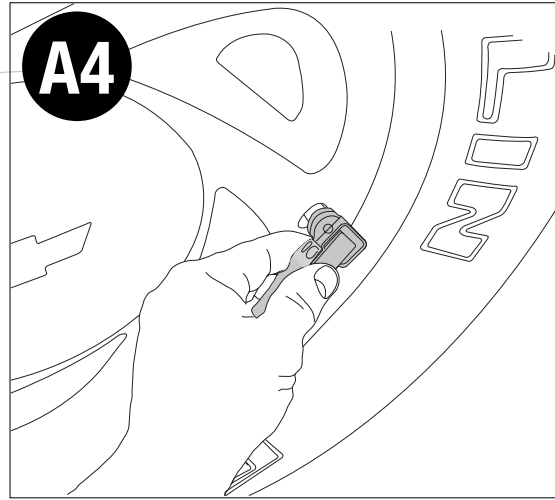
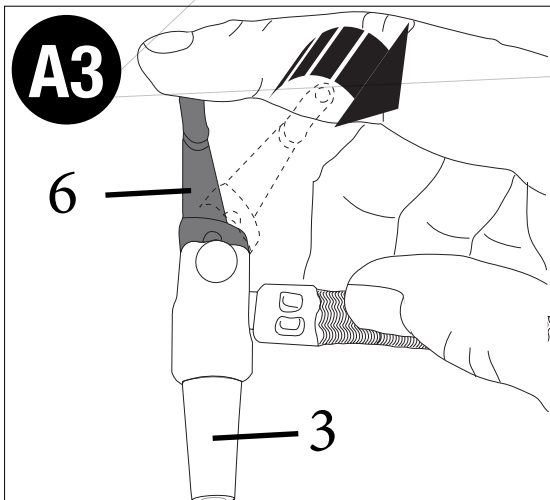
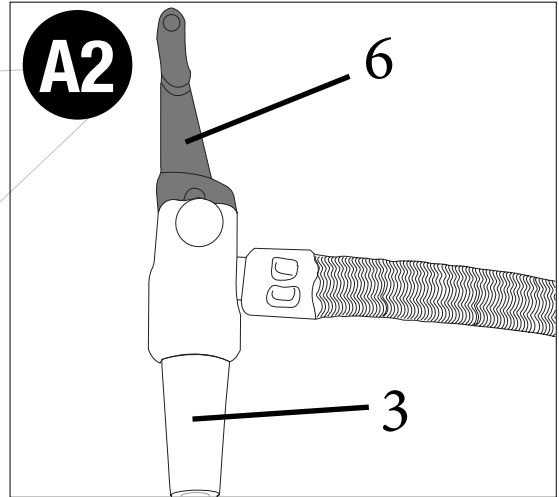
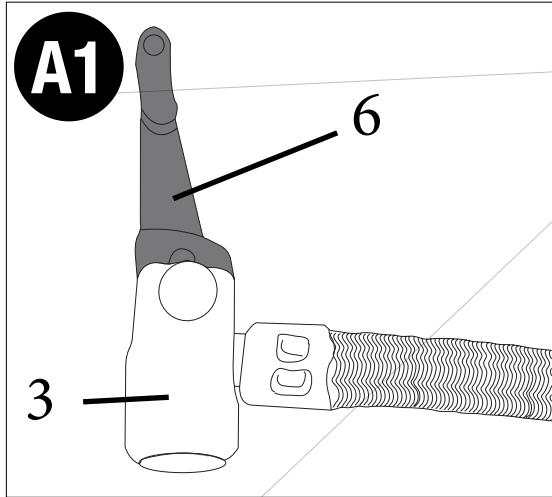

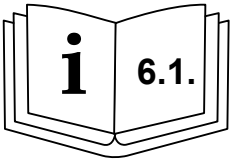
**FIG. 2**





		<b>MINI COM 12V</b>
	W	<b>90</b>
V <sub>1</sub>	V	<b>12</b>
	Kg/cm <sup>2</sup>	<b>17</b>
	L/min	<b>30</b>
		<b>II</b>
	kg	<b>0,40</b>

This manual is in conformity with the date of manufacture of your machine; you may find this information in the technical datasheet of the acquired machine, and look for updates on our website:

[www.grupostayer.com](http://www.grupostayer.com)

Its inflating device is designed for use inside the car with a standard 12V standard plug and its adaptor cable. As any other battery driven apparatus, when the inflating device is used in the 12V operating mode, its performance varies in direct relationship with the load condition of the battery. Naturally, the higher the current generated by the inflating device, the more energy of the battery is reduced.



Read all instructions before operating the product. Non-fulfillment of each and any of the below instructions may cause electric discharge, fire or serious injuries.



The packaging materials are no toys! Children must not play with plastic bags! There is a risk of suffocation!



Contact the seller should any parts be missing or should there be damaged parts.

## 1. Index

<b>2. Istruzioni specifiche di sicurezza .....</b>	<b>13</b>
<b>3. Instructions for putting into operation .....</b>	<b>14</b>
3.1 Positioning .....	14
3.2 Assembling.....	14
3.3 Illustrated description.....	14
<b>4. Operating instructions .....</b>	<b>14</b>
4.1 Positioning and testing.....	14
4.2 Setting operations.....	14
<b>5. Servicing and cleaning instructions.....</b>	<b>15</b>
5.1 Cleaning and servicing .....	15
5.2 Repair service.....	15
5.3 Guarantee.....	15
5.4 Disposal.....	15
<b>6. Regulatory Marking.....</b>	<b>15</b>
6.1 Technical specifications .....	15
6.2 EC Declaration of Conformity .....	15

## 2. Specific safety instructions



**Read all instructions before operating the product. Non-fulfillment of each and any of the below instructions may cause electric discharge, fire or serious injuries.**

**USE THE ADEQUATE TOOL Do not force tools or small accessories to make them do the work of a tool for heavy works. Do not use the tool for purposes different from those it is foreseen.**

**DO NOT OPERATE** portable electrical tools near to inflammable liquids or in gaseous or explosive atmospheres. The motors of these tools usually give off sparks, and the sparks may ignite vapors.

**WARNING! For use at home and automobiles only:**

Inflate automobile and bicycle tires, balls, rubber dinghies, swimming rings, inflatable mattresses and mote at or about your home.

**WARNING! Respiratory risk:**

It is not safe to breathe in compressed air getting out of your inflating device. Never inhale the air of your inflating device or of a respiratory device connected to the inflating device.

**WARNING! Explosion hazard:**

- Inflate elements in accordance with manufacturer's recommendations, as they may explode and cause personal injuries when their maximum pressure value is exceeded.
- Do not leave the inflating device unattended during operation. It might cause tires or other elements to explode.

**WARNING! Hazard of electrical discharge:**

- Switch off and unplug the inflating device when not in use, when cleaning it or when changing nozzles.
- Do not expose the inflating device to rain or humid conditions. Hazard of electric discharge increases if water enters into the inflating device.

**WARNING! Risk of falling down:**

- As the vibration produced by the inflating device may make it "walk", do not make it operate it on a shelf or other high surface, but on floor level or that of a bank.

**WARNING! Risk of unsafe operation:**

- Do not modify or attempt to repair the device. Never perforate, weld nor make any modification to the inflating device or the elements thereof.
- Do not operate the inflating device when the motor of automobile is running.
- Do only use the unit with the accessories as included. Use of accessories that are not recommended by us may be dangerous.
- Never use it as a toy. High-pressure air is dangerous. Do not direct the air flow towards yourself or other people.

**WARNING! Risk of fire:**

- The inflating device may heat up when used during 10 minutes. Allow it to cool down for 30 minutes before storing it or using it again. Do not use more than 10 minutes.

TABLE OF SAFETY ICONS			
	Indicates risk of body injury or material damages		
	Read this manual before using the apparatus.		Use safety gloves.
	In conformity with fundamental regulations of European Directives.		Use mask, ear protectors and safety goggles
	Type II tool – double isolation – does not require plug with grounding connection.		

### 3. Instructions for putting into operation

#### 3.1 Positioning

Keep working area clean and orderly. Disorderly and little illuminated areas favor work accidents.

Do not use electric tools in potentially explosive atmospheres or in the presence of inflammable liquids, gases or powders. Electric tools cause sparks that may ignite powders or smoke.

Keep children and other people away while using the electric tool. Getting distracted may make you lose control over the machine.

#### 3.2 Assembling

##### Valve Adapter (FIG. 2)

•Push adapter 6 downwards onto the threaded section of the valve rod or one of the three accessories delivered together with the inflating device (fig. A2).

•When the adapter is positioned completely down on the threads, press lever 6 with your finger downward so as to fix it in its position (figure A3).

•To release the adapter 3, pull lever 6 upwards and pull the adapter 3.

•Operate your inflating device only with the nozzles as included or with standard valves for tires (figure A4).

##### Accessories

• Place the universal valve adaptor 3 over the stud of the inflator needle or the conical nozzle.

• Press lever 6 of the universal valve adaptor downward until it wedges into its position.

• Put inflator needle 10 or the conical nozzle into the object that is to be inflated.

##### Remark:

The conical nozzles 9 and standard extension nozzles 11 and the inflator needle 10 shown in figure C are delivered together with the compressor.

#### 3.3 Illustrated description

1. Universal adapter sleeve air valve
2. Cord
3. Universal adapter for valves.
4. Gauge
5. Motor housing
6. Lever universal adapter
7. Switch on / off
8. 12V Plug
9. Standard nozzle
10. Needle for inflating
11. Nozzle extension

### 4. Operating instructions

#### 4.1 Positioning and testing

To switch the compressor on, you must use the ON/OFF switch 7 located at the upper portion of the compressor.

##### Connection to power supply:



##### Risk of unsafe operation

• Do not operate the compressor when the motor of the automobile is running.

• Always completely extend the 12V DC cable 2 before each use.

• To turn the compressor on, plug the 12V adapter into the vehicle's 12V socket for accessories, and press switch 7 towards red in position "I".

To turn the compressor off, press switch 7 into position "O".

#### 4.2 Setting operations:



**Risk of explosion. Too much air pressure causes risk of blasting. Check which is the maximum pressure established by the manufacturer of the articles that will be inflated.**

• To operate the valve adapter 3, position the lever 6 upward and then penetrate the valve to inflate the object adapter or floating (9-11) or balls (9) and close the lever 6 to seal the circuit (Figure A1-A4)

• To activate the compressor, connect the adapter to 12 volt accessory outlet 12 volt vehicle and press the red switch to position "I".

• If necessary, turn the key to start the car capable of powering a contact.

• To turn off the compressor, press the 7 "O".

**REMARK:** Let the lever 6 always in its upward position when not in used.

##### Manómetro

This gauge located on the upper portion of the inflating device, will provide you with a lecture in PSI (pounds per square inch) and as well in kilo Pascal: kg/cm2 Newton per square meter). In the case of vehicle tires, it is recommended to control the pressure lecture with another gauge for tires.

Problem	Possible cause	Possible solution
•The unit does not start..	<ul style="list-style-type: none"> <li>• adjusted pressure may be below the actual pressure.</li> <li>• fuse blown in the 12V adapter.</li> <li>• indicator is in contact with the pressure needle.</li> <li>• cable unplugged.</li> <li>• automatic switch triggered.</li> <li>• switch or cable damaged.</li> </ul>	<ul style="list-style-type: none"> <li>• replace adapter and cable.</li> <li>• plug recharger into another socket.</li> </ul> <p>Servicing at a STAYER Service Center or an authorized service center.</p>

**RECOMMENDED OPERATING PRESSURES (see TABLE 1 – page 8)**

## 5. Maintenance and servicing instruction

### 5.1 Cleaning and servicing

To clean the tool, only use a damp cloth. Never allow water penetrating into the tool, and do not immerse any of its parts into a liquid, making sure that you have disconnected the plug from the electrical power point.

### 5.2 Servizio de Riparazione

The customer service will provide you with advice on your eventual inquiries regarding repair and maintenance of your product as well as on spare parts.

You may also obtain Exploded view drawings and information on the spare parts on the internet under: [info@grupostayer.com](mailto:info@grupostayer.com)

Our team of technical advisors will be happy to advise you in respect of the acquisition, application and settings of the products and accessories.

### 5.3 Guarantee

#### Guarantee card

Among the documents forming a part of the electric tool, you will find the guarantee card. You should fill in the guarantee card completely and, applying the sales slip or invoice thereto, and deliver it to your retailer in exchange for the corresponding acknowledgement of receipt.

**!REMARK! If this card were missing, immediately ask you retailer for it.**

The guarantee is limited to manufacturing or machining failures, and ceases when the parts have been disassembled, manipulated or repaired out of works.

### 5.4 Disposal

We recommend subjecting all electric tools, accessories to a recycling respecting the environment.  
For EU countries only:

#### Do not throw electric tools to the garbage!



According to European Directive 2002/96/EC on electric and electronic devices, after transposition thereof into national law, electric tools must be collected separately so as to be subject to ecologic recycling.

**Right to change reserved.**

## 6. Regulatory Marking

### 6.1 Technical specifications

 = nominal power

$V_1$  = voltage

 = nominal pressure

 = flow rate

 = protection class

 = weight

Pay attention to the article number on the feature plate of your device.

### Information on noise and vibration

Noise determined according to EN 60745.

The typical sound pressure level as determined with an A filter, amounts to: Sound pressure level 88 dB(A); acoustic power level 99 dB(A). Tolerance K=3 dB.



#### Wear ear protectors!!

Livello totale di vibrazioni (somma vettoriale di tre direzioni) determinato secondo EN 60745: levigatura di parete di gesso  $a_h = 4 \text{ m/s}^2$ ,  $K = 1,5 \text{ m/s}^2$ .

Total level of vibrations (vector sum of three directions) determined according to EN 60745: Plaster wall sanding  $a_h = 4 \text{ m/s}^2$ ;  $K = 1.5 \text{ m/s}^2$ .

The level of vibrations stated in these instructions has been determined according to regulation EN 60745, and may serve as a basis for comparison with other electric tools. The level of vibrations as stated has been determined for the main applications of the electric tool. Therefore, the level of

vibrations may be different where the electric tool is used for other applications with different implements, or where maintenance thereof were deficient. This may result in a drastic increase in vibration stress during the whole working period.

So as to determine exactly the stress suffered by vibrations, it is necessary to consider as well those periods where the apparatus is disconnected or also it is working but without being used really. This may result in a drastic reduction of the stress by vibrations during the whole working period. Establish additional safety measures to protect the user against the effects of vibrations, as for example: Maintenance of the electric tools and of the implements, keeping hands warm, organization of the work sequences.

### 6.2 Declaration of conformity CE

The undersigned: STAYER IBERICA, S.A.

With address at:

Calle Sierra de Cazorla, 7

Área Empresarial Andaluc a - Sector 1

28320 PINTO (MADRID)

Tel.: +34 91 691 86 30 / Fax: +34 91 691 86 31

**CERTIFIES**

**That the machine:**

Type: **MINI COMPRESOR**

Model: **MINI COM 12V**

We declare under our own responsibility that the product as described under "Technical Data" is in conformity with the following standards or standardized documents: EN UNE EN 60745-1:2010/A11:2011, UNE EN 60745-2-3:2011/A2:2013 in accordance with REGULATIONS 2004/108/EC, 2006/42/ECE

**Ramiro de la fuente**  
 Director Manager  
 January, 2017

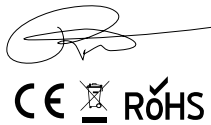

**TABLE 1 – RECOMMENDED OPERATING PRESSURES**

Function	Application	Inflating pressure (in bar)	Operating pressure (in bar)
Inflating	To inflate: soccer balls	0,8-1**	1-4
	Pneumatic boats, inflatable beds, swimming pools for children	0,5-1**	
	Tires	2-3	
	Common bicycle tires	1-3	
	BTT Tires	2-2,5	
Blowing	To remove dust from ordinary articles		8
	To remove dust from precision equipment		4
Painting*	To paint small surfaces at low pressure		2-3
	For works with pneumatic brush		1,5-2
Washing/ spraying*	For washing with air/water gun		8
	For spraying detergents onto motors		8
	For spraying water/products onto plants		8
Riveting/ nailing	For wood works		6





**STAYER**

Área Empresarial Andalucía - Sector 1  
C/ Sierra de Cazorla, 7  
28320 - Pinto (Madrid) SPAIN  
Email: sales@grupostayer.com  
Email: info@grupostayer.com



**ROHS**

[www.grupostayer.com](http://www.grupostayer.com)